

D (1:3)

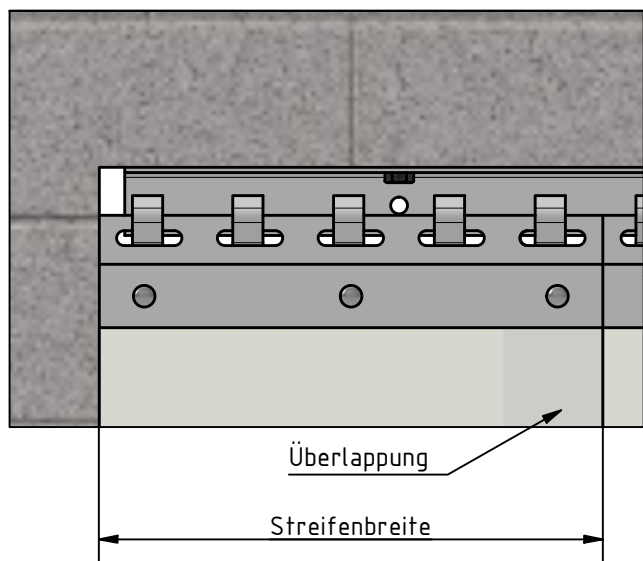

B →

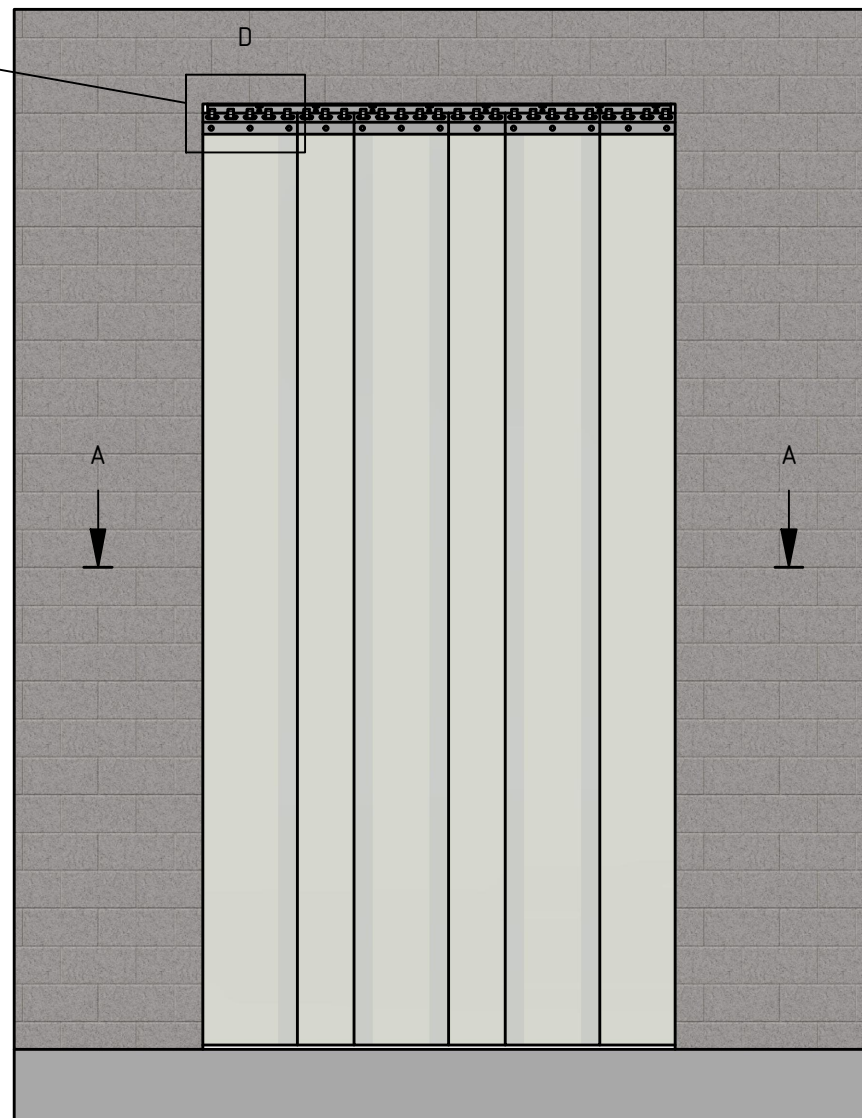

A ↓

A ↓

B →

B-B (1:16)

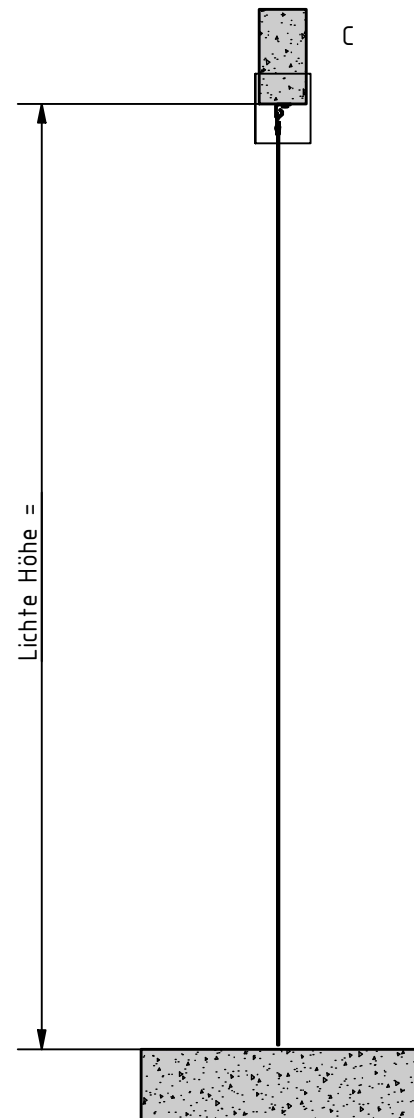

C (1:2)

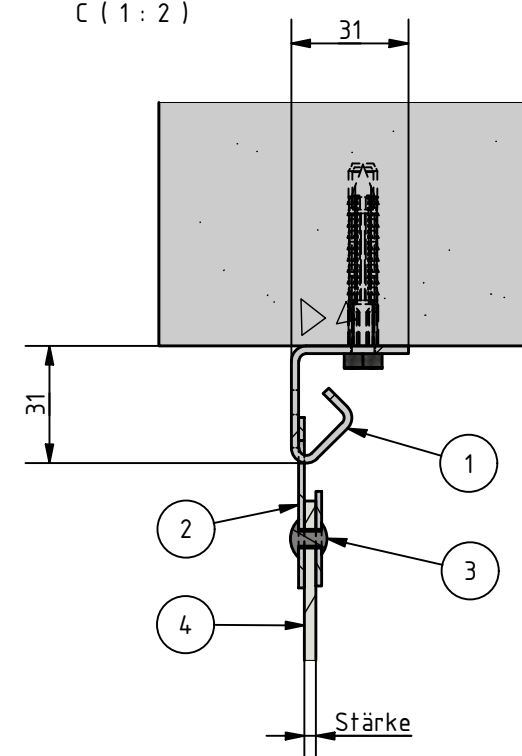

TEILELISTE	
OBJEKT	BESCHREIBUNG
1	Hakenschiene
2	Halteklammer mit Gegenplatte
3	Schlagniete
4	PVC Streifen

ISO (1:32)

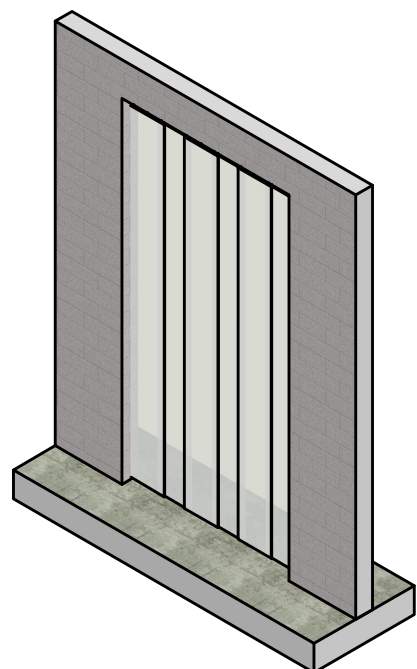

A-A (1:16)

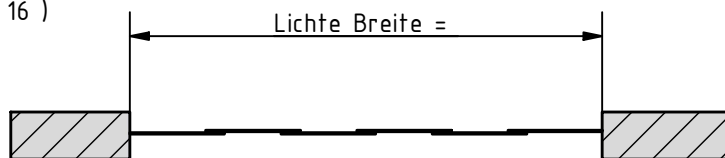

Maßstab 1:16

Datum: 16.10.2024

geZ.:rouven.kriesten

PVC Streifenvorhang EH

Type "Einhängesystem"

Unter Sturz Befestigung

WI-006935

Kunde

AB.Nr.

BV.



Blatt Nr. 1
Format A3
Rev. R00

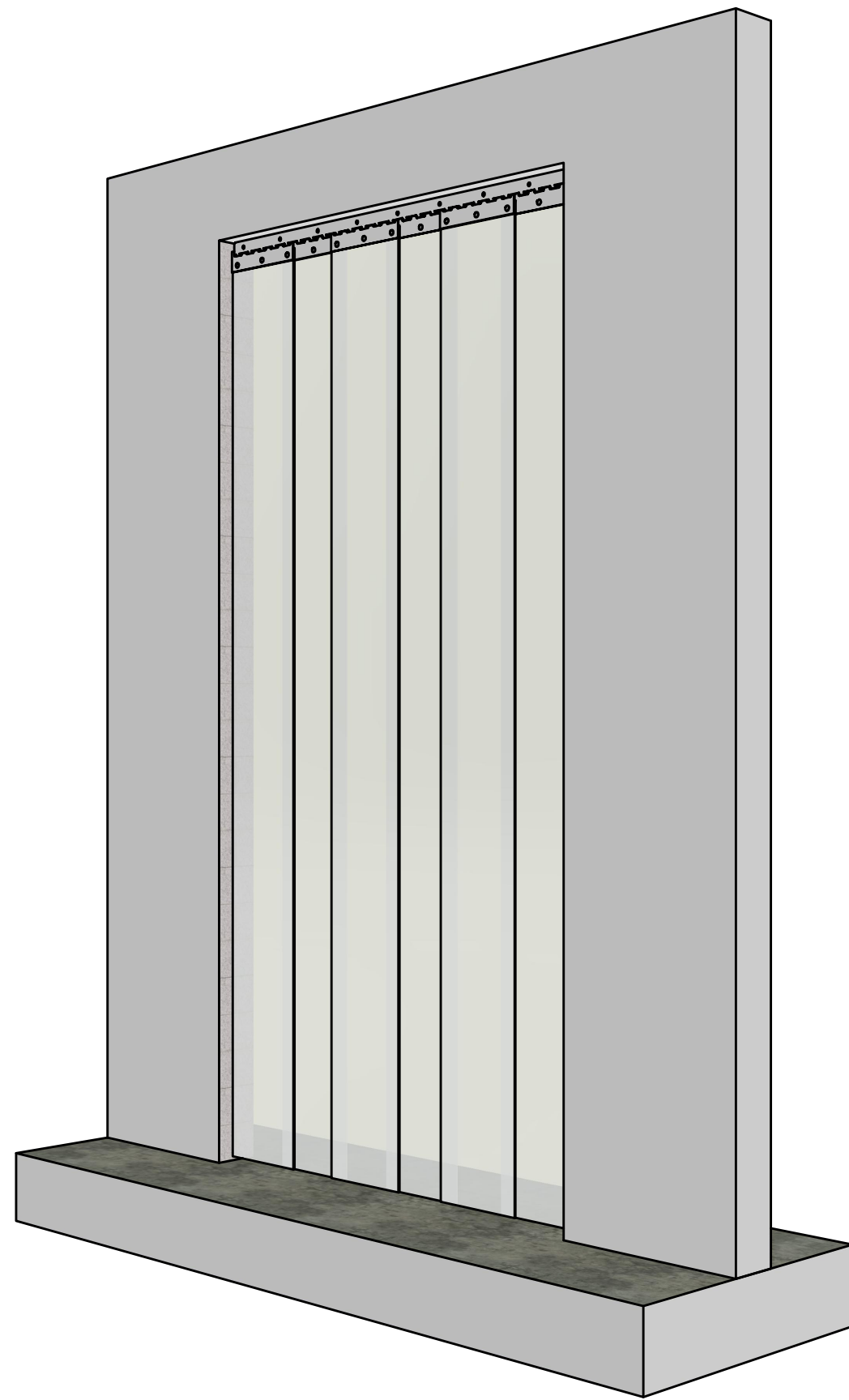
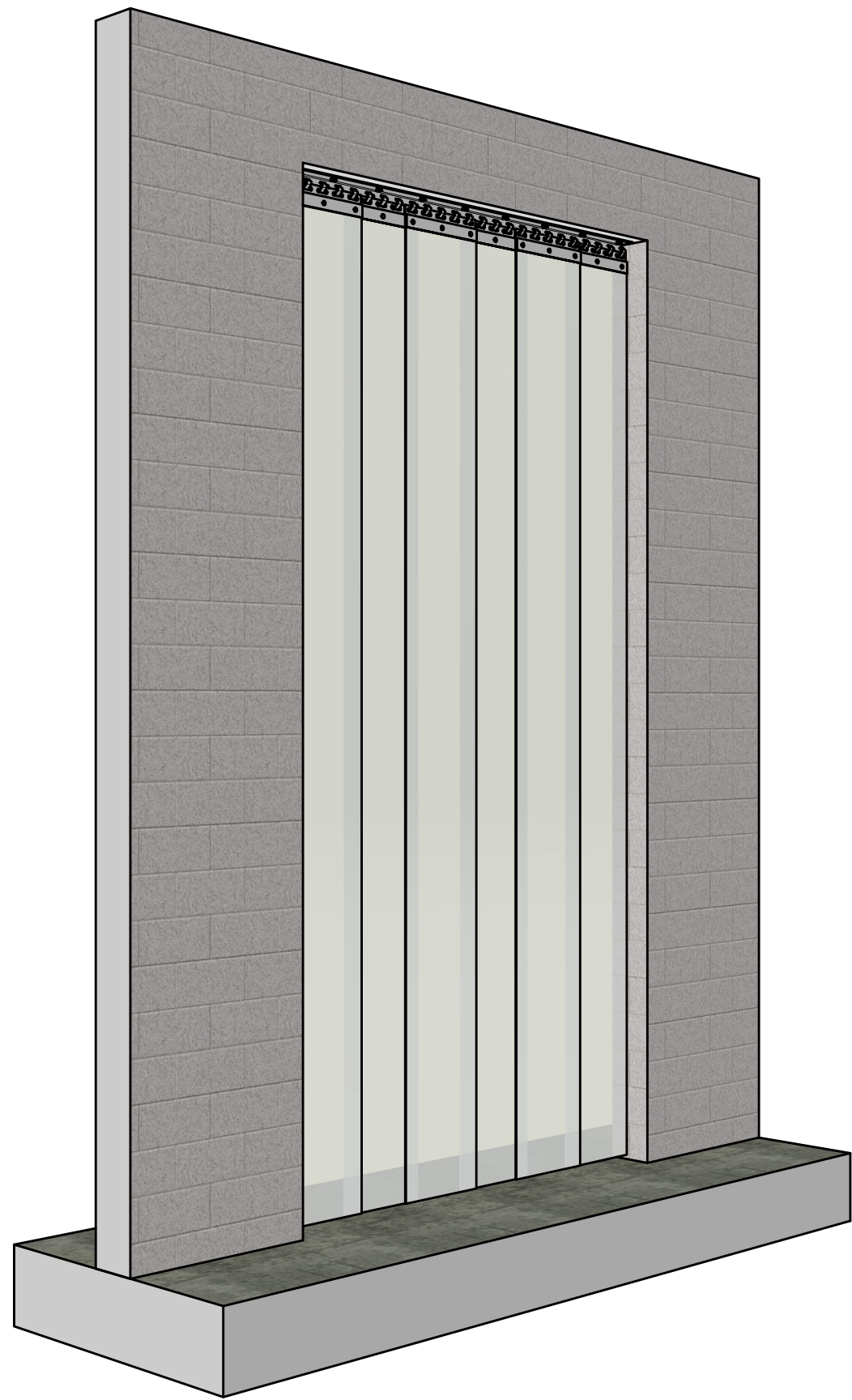

Maßstab 1 : 12	PVC Streifenvorhang EH	Kunde	 Blatt Nr. 2 Format A3 Rev. R00
Datum: 16.10.2024	Type "Einhängesystem"	AB.Nr.	
geZ.:rouven.kriesten	Unter Sturz Befestigung	BV.	
	WI-006935		

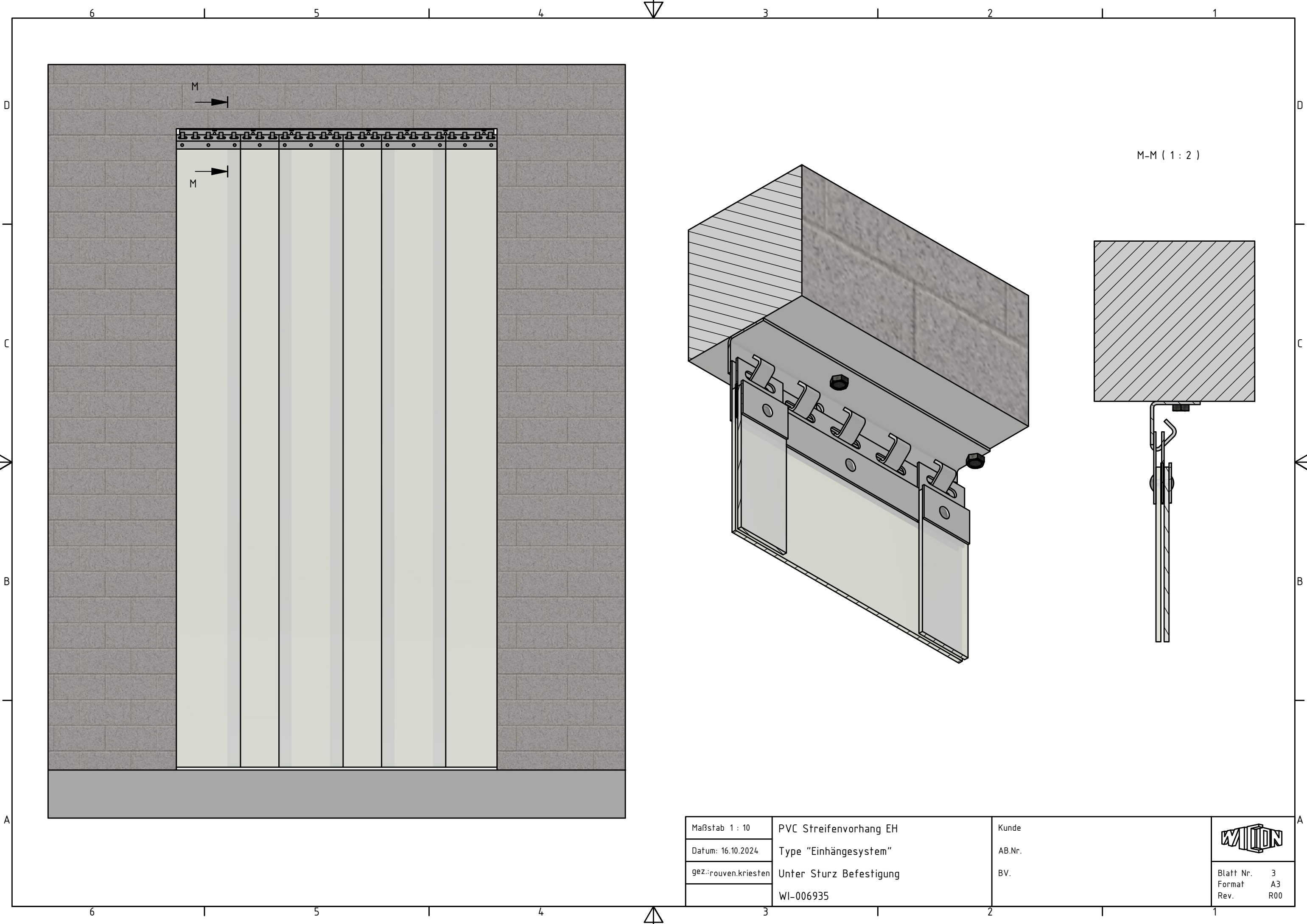

Maßstab 1 : 10	PVC Streifenvorhang EH	Kunde	 Blatt Nr. 3 Format A3 Rev. R00
Datum: 16.10.2024	Type "Einhängesystem"	AB.Nr.	
geZ.:rouven.kriesten	Unter Sturz Befestigung	BV.	
	WI-006935		